

PREXISO

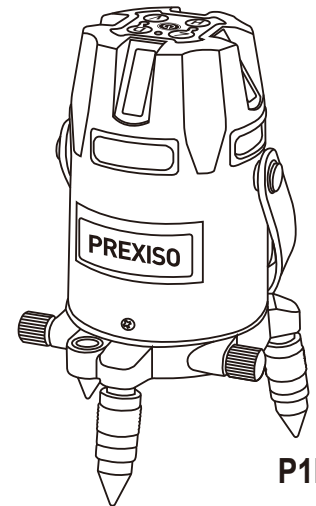

P1E4V4H

MULTI-LINE LASER LEVEL



www.prexiso-eu.com

SAFETY INSTRUCTIONS

Working safely with the measuring tool is possible only when the operating and safety information are read completely and instructions contained herein are strictly followed. Never make warning labels on the measuring tool unrecognizable. **SAVE THESE INSTRUCTIONS.**

Caution – The use of operating or adjusting equipment or the application or processing methods other than those mentioned herein, can lead to hazardous radiation exposure.



<1.0mW @ 630-640nm
IEC/EN 60825-1: 2014



WARNING

LASER RADIATION. Do not stare into beam. Class II laser product. Turn the laser beam on only when using this tool.

- **Do not remove or deface any product labels.**
- **Avoid direct eye exposure.** The laser beam can cause persons being blinded.
- **Do not operate the tool around children or allow children to operate the tool.**
- **Do not place the tool in a position that may cause anyone to stare at the laser beam, whether intentionally or unintentionally.**
- **Do not use on reflecting surfaces** such as sheet steel, glass or polished metal etc. that have shiny, reflective surfaces. The shiny surface could reflect the beam back at the operator.
- **Always turn the laser tool off when not in use.** Leaving the tool on increases the risk of someone inadvertently staring into the laser beam
- **Do not attempt to modify the performance of this laser device in any way.** This may result in a dangerous exposure to laser radiation.
- **Do not attempt to repair or disassemble the laser-measuring tool.** If unqualified persons attempt to repair this product, serious injury may occur. Any repair required on this laser product should be performed only by qualified service personnel.
- Use of other accessories that have been designed for use with other laser tools could result in serious injury.
- **Do not operate the tool outdoors.**
- **Do not place or store tool under extreme temperature conditions.**

- **Do not** operate the tool in explosive environments, such as in the presence of flammable liquids, gases or dusts. Sparks can be created in the tool which may ignite the dust or fumes.
- Keep the tool **away from** cardiac pacemakers. The magnet inside the tool generates a field that can impair the function of cardiac pacemakers.
- Keep the tool **away from** magnetic data medium and magnetically-sensitive equipment. The effect of the magnetic can lead to irreversible data loss.
- Measurement **may not** be accurate if used beyond the rated range of the device.
- The use of optical instruments with this product will increase eye hazard.
- **Always** make sure any bystanders nearby aware of the dangers of looking directly into the measuring tool.
- **Do not** use the laser viewing glasses as safety goggles, they do not protect eyes against laser radiation.
- **Always** remove the batteries when cleaning the laser light aperture to laser lens.

FUNCTION

- Including four vertical lines, four horizontal lines and one plumb line.
- Self-leveling function: range is 3.5°. When the instrument inclines over ±3.5°, the laser line goes out automatically to issue an alarm.
- Rotate fine adjustment mechanism, making it easier to find object correctly.
- Fast horizontal and vertical magnetic damping self-leveling.
- Accuracy: ±1mm@5m.
- Manual mode: locks the line and sets the level at any desired angle.

TECHNICAL SPECIFICATIONS

COMPONENT	SPECIFICATIONS
Self-leveling range	± 3.5°
Accuracy	± 1 mm / 5 m
Laser wavelength for line laser	630-645 nm
Laser wavelength for plumb laser	648-660 nm
laser output power	Class 2 laser, maximum laser output<1mW
Power supply	Ni-MH rechargeable battery or 4 x AA Alkaline battery
Battery operating time (all lasers on)	Approx. 4.5 h
Battery recharging time	Approx. 5 h
Operating temperature	-10°C ~ 40°C (14°F~104°F)
Storage temperature	-20°C ~ 70°C (-4°F~158°F)

DESCRIPTION

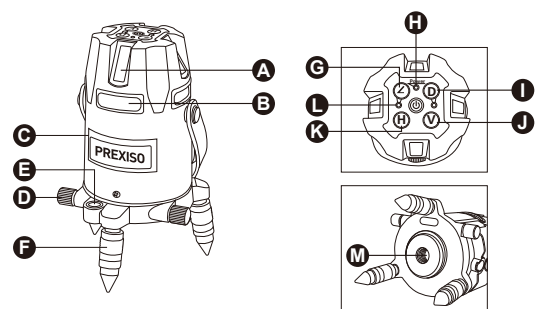

PARTS	DESCRIPTION
A	Vertical laser aperture
B	Horizontal laser aperture
C	Battery compartment(rear)
D	Fine tune knobs
E	Vial for alignment
F	Adjustable feet with removable rubber cover
G	Incline mode button
H	Power indicator
I	Outdoor mode ON/OFF
J	vertical laser line
K	horizontal laser line
L	Incline mode indicator
M	Plumb laser aperture

UNPACKING

When unpacking the box, do not discard any packing materials until all of the contents are accounted for:

- Multi-line laser level
- Red target
- Red laser glasses
- Charger for laser level
- 4xAA size Ni-MH rechargeable batteries
- Operator's manual
- Aluminum Case

Carefully lift the compact laser measuring tool out of the package and place it on a stable, flat surface.

OPERATION INSTRUCTION

1. Use of the batteries

Before using the product for the first time, insert the battery into the device and fully charge it (5hours for the empty battery). The batteries will be fully charged when the LED of the charger changes to green from red.

NOTE:

- The device also can work with the AA alkaline batteries.
- Remove the batteries from the measuring tool when not using it for extended periods. When storing for extended periods, the batteries can corrode and discharge themselves.

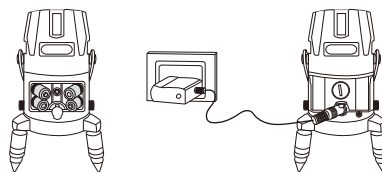

2. Self-levelling by the electric system

When the device is placed on the uneven surface and turned on by ON/OFF button, it will level itself by the electric system with the incline indicator flashing and continuous sound of mechanical parts movement. When the light of incline indicator goes off, the levelling is accomplished.

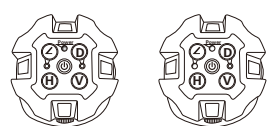

2. Horizontal and vertical levelling mode

Turn the rotary switch clockwise to "ON" symbol, the power indicator will light up, and the pendulum system will be unlocked and is ready to work.



Press "H" to switch the different horizontal laser levelling mode in the following order.

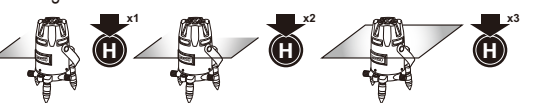

Press "V" to switch the different vertical laser levelling mode in the following order.

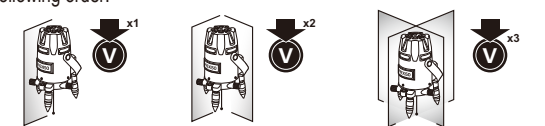

NOTE:

-If the device is too far off from horizontal (more than 3.5°), The laser will blink. Please put the device on more flat surface with the help of the adjustable feet. The vial on the device can be used to align to the level.

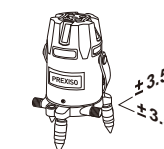

-The laser can be fine adjusted by the fine-tune knob.

3. Work with the receiver

Press "D" to switch on the Detector mode. Use the receiver to carry out the levelling at great distances or when the laser lines are no longer visible.

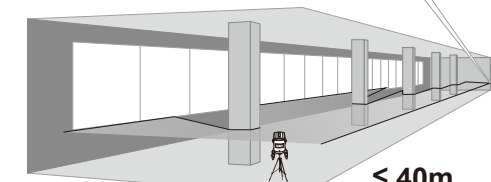
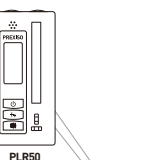

4. Use with the Tripod

At the bottom of the tool, a 5/8"nut is located. Mount the tool to the tripod (not included) by assembling the tool nut with the 5/8" screw on the tripod. With the accessories, the tool can work under various applications which makes jobs done easier.

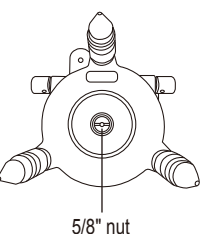

5. Slope mode

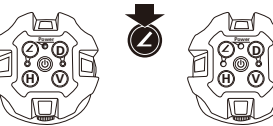

Press inline button to light on the incline indicator. The pendulum system will be locked and laser beam will be fixed. Then the device can be put on the inclined surface or set up on the tripod to measure the sloping planes and tiles

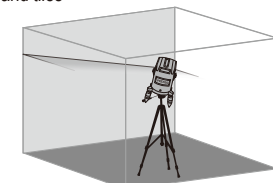

Note:
-After slope mode is turned on and the incline indicator light up, "D", "H", "V" button will be invalid.

APPLICATIONS

- The Multi-line laser level can be placed on the ground, mounted on a work bench / door frame etc. for point marking and simple alignment by sight. It is ideal for the following applications:
- Hanging pictures, photos, or artwork on walls
 - Wallpapering and stencil work
 - Framing doors and windows
 - Installing electrical wiring and pipes
 - Mounting wall fixtures, electrical outlets, switches and lighting
 - Installing a drop ceiling
 - Painting
 - Installing cabinets
 - Laying tile and flooring

MAINTENANCE

This compact laser measuring tool has been designed to be a low-maintenance tool. However, in order to maintain its performance, you must always follow these simple directions:

- **Avoid** exposing the tool to shock, continuous vibration or extreme hot or cold environment.
- **Always** store the tool indoors.
- **Always** keep the tool free of dust and liquids. Use only a clean soft cloth for cleaning. If necessary, slightly moisten the cloths with pure alcohol or a little water.
- **Do not** disassemble the compact laser measuring tool, this will expose the user to hazardous radiation exposure.
- **Do not** attempt to hazard any part of the laser lens.

TROUBLESHOOTING

PROBLEM	CAUSE	SOLUTION
The laser line projection is weak.	Batteries are weak.	Replace with new batteries or charge the batteries.
The laser line is hard to see.	The tool is out of the rated operating range	Move the tool closer to be within the rated operating range.
Laser line is not projected.	No batteries installed or batteries are depleted.	Install new batteries.
Laser line flickers for alert.	The surface where the tool has been placed is uneven or the tool is working under manual mode.	Place the tool on flat surface levels within +/-3.5 degrees.

DISPOSAL

CAUTION

The battery must not be disposed with household waste. Care for the environment and take them to the collection points provided in accordance with national or local regulations. The product must not be disposed with household waste. Dispose of the product appropriately in accordance with the national regulations in force in your country. Adhere to the national and country specific regulations. Product specific treatment and waste management can be downloaded from our homepage.



WARRANTY

Two-Year Limited Warranty. This product is warranted to the original purchaser from the original purchase date for two years subject to the warranty coverage described herein. Please retain your receipt. This product is warranted to the original user to be free from defects in material and workmanship. If you believe that the product is defective at any time during the specified warranty period, please contact Prexiso customer service agent by sending email to info@prexiso-eu.com. This warranty does not cover:(1) Part failure due to normal wear or product abuse;(2) Any parts have been altered or modified by anyone other than an authorized Prexiso personnel or failure to install and operate equipment according to the guidelines put forth in the instruction manual.(3)Any products or parts used for rental purposes, damage resulting from shipping (claims must be filed with freighter), accident, abuse, act of God, misuse, or neglect. Prexiso will replace or repair the defective unit, at its option, subject to verification of the defect. Any implied warranties arising from the sale of a Prexiso product, including but not limited to implied warranties of merchantability and fitness for a particular purpose, are limited to the above. Prexiso shall not be liable for loss of use of the product or other incidental or consequential damages, expenses, or economic loss, or for any claim of such damage, expenses, or economic loss. This warranty excludes any accessories. This warranty gives you specific legal rights, and you may also have other rights that vary from state.



Printed in China

Prexiso AG
Fabrikstrasse 1
CH-8586 Erlen / Switzerland
www.prexiso-eu.com