

IMPORTANT:
Read before Using

EN

PREXISO

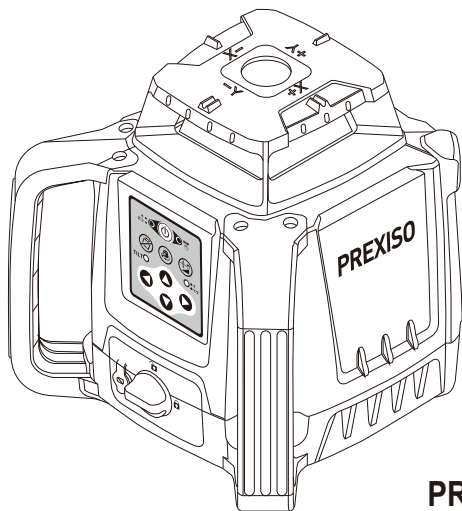

PR500HV

SELF-LEVELING ROTARY LASER

2 LIMITED
YEARS WARRANTY

www.prexiso-eu.com

IMPORTANT SAFETY INSTRUCTIONS

 Do not use the product before you have studied the Safety instructions and the User Manual on the enclosed CD or on our Homepage.

If you have no such manual, or it is in the wrong language, please ask your agency for an appropriate copy.

The product is permitted to use for skilled persons only.

WARNING:

- It is a **Class 2** laser product in accordance with IEC 60825-1:2014
- The following labels are on your laser tool for your convenience and safety.



- Do not stare into the laser beam or direct it towards other people unnecessarily.
- Don't dazzle other individuals.
A measurement could be triggered at any time.
- Looking directly into the beam with optical aids can be hazardous.
- Do not operate the product in explosion hazardous areas or in aggressive environments.
- Only use chargers recommended by the manufacturer to charge the batteries.
- Keep extremities in a safe distance from the moving parts.
- Watch out for erroneous measurements if the product is defective or if it has been dropped or has been misused or modified.
- Carry out periodic test measurements.
Particularly before, during and after important measurements.
- The product and batteries must not be disposed of with household waste.

Goggles:



WARNING!

The goggles do not protect your eyes against the laser beam.
They are only used to increase the visibility of the laser.

PRODUCT OVERVIEW

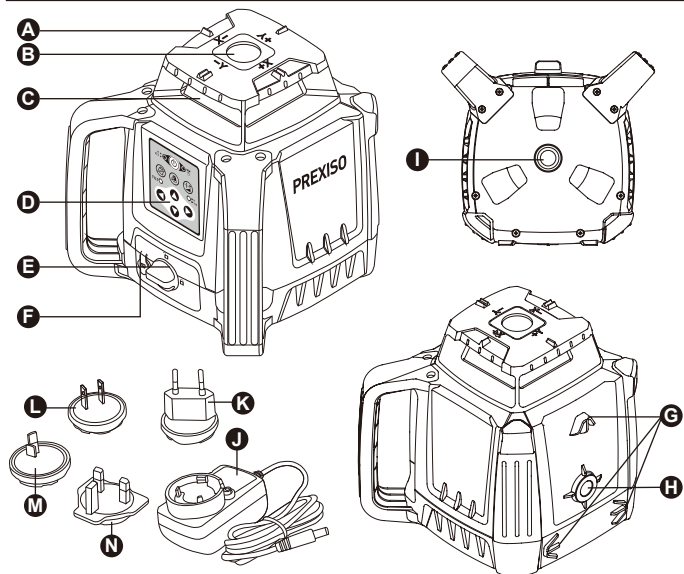

PARTS	DESCRIPTION	PARTS	DESCRIPTION
A	Alignment Sight	H	5/8" insert
B	Vertical Up Beam Window	I	5/8" insert
C	Rotary Laser / Glass Enclosed	J	Charger
D	Keypad	K	Plug(EU, China)
E	Battery lock switch	L	Plug(US, Japan, China)
F	Power Adapter Plug Jack	M	Plug(Australia)
G	Vertical support dot	N	Plug(UK)

KEYPAD AND LED

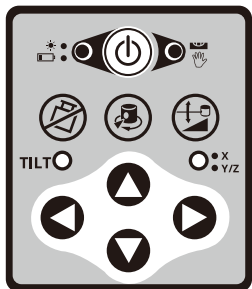

On/Off



Tilt warning on/off



Scan mode
/Speed



Slope



Up



Down



Left



Right

LEDs

POWER-LED



- Blinking Green: Laser Tool is Auto-Leveling In Calibration and / or Default Tilt Warning Set Up
- Solid Green: Auto-Leveling Complete
- Blinking Red: Low Battery
- Solid Red: Battery Needs Recharging

MAN-LED



- Solid Red With POWER-LED – Solid Green: Manual Mode On (Auto-Leveling Off)
- Blinking Red With POWER-LED – Blinking Green: Out of Compensation Range

TILT ○

- Solid Green: Tilt Warning On
- Solid Red: Tilt Warning Alarm

○ ● X ● Y/Z

- Solid Green: X Axis Adjust Slope Mode
- Blinking Green:
 - X Axis at Maximum Allowed Slope in Slope Mode
 - X Axis Adjust Calibration Mode
- Solid Red: Y Axis Adjust Slope Mode
- Blinking Red:
 - Y Axis at Maximum Allowed Slope in Slope Mode
 - Y Axis Adjust Calibration Mode

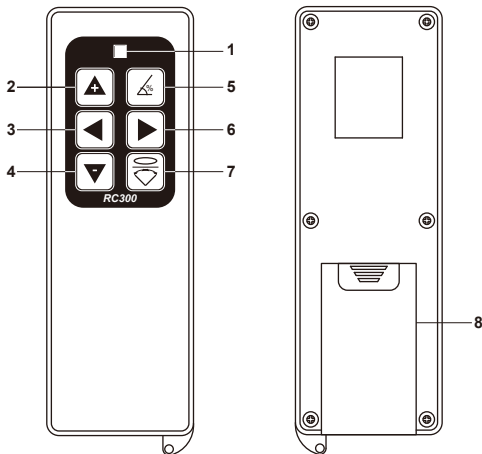

1. Light indicator
2. Speed switch button(Press this button to switch the laser beam rotating speed from 300rpm->600rpm->0rpm->300rpm).
3. Laser dot moving button (Press this button to clockwise move the laser dot).
4. Speed switch button(Press this button to switch the laser beam rotating speed from 300rpm->0rpm->600rpm->300rpm).
5. Slope
6. Laser dot moving button (Press this button to anticlockwise move the laser dot).
7. Scan mode/Speed
8. Battery lid (Open the battery lid and insert 2 x1.5V AA batteries into the battery compartment).

BATTERIES AND POWER

Battery Installation / Removal Li-Ion Battery version

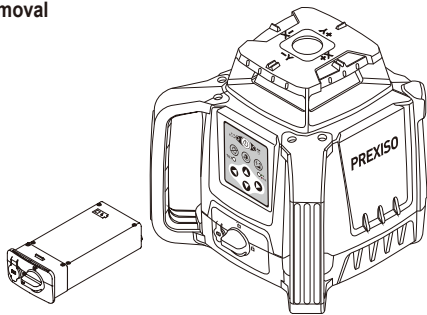

⚠ WARNING:

- Use charging / power adaptor only with Li-Ion battery pack supplied.
Charging any other type of battery may result in damage and/or personal harm.
- The battery and charging / power adaptor can be damaged if damp.
Always store and charge the tool in a dry and covered place.

⚠ NOTE:

- For best battery life, it is recommended to charge the battery once it has been fully discharged and avoid letting charge for >10 hours at a time.

Operating with Charging / Power Adaptor

- Laser tool can operate while plugged into charging / power adaptor.
Functions and controls of laser tool are the same as when not plugged into charging / power adaptor.

Alkaline Batteries version

⚠ WARNING:

- Pay close attention to the battery holder's (+) and (-) markings for proper battery insertion. Batteries must be of same type and capacity. Do not use a combination of batteries with different capacities remaining.

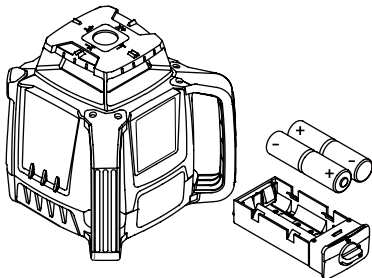

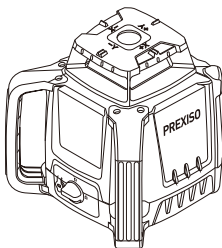

Horizontal Position

- Place laser tool down on its bottom. Be sure surface is near level.
- Press  to power ON.

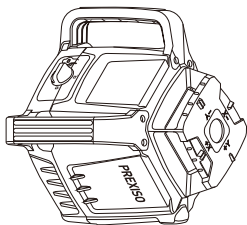

Vertical Position

- Place laser tool down on its side, handle facing up. Be sure surface is near level.
- Press  to power ON.

At Angle





- Press to power ON. Press and hold to turn ON Mnual Mode. Laser tool can now be positioned to various angles with auto-leveling mode OFF.

NOTE:





To change between horizontal and vertical positions the laser tool must be powered OFF, repositioned, and then powered ON in the new position.

OPERATION





















Operation in Auto Mode

- Press  to turn on the instrument.
-  Green LED is blinking green when the instrument start to leveling. **TILT LED** is off (**TILT Function** is not on by default), the laser is glitter.
- After leveling, the laser dot starts to rotate(the default speed is 300rpm),laser is kept bright,  Green LED and **TILT LED** are solid green.
- The instrument will be warning when it is tilted, and rotating will be stopped, the laser will be glitter, **TILT LED** is solid red. Press  to reset.
- Press  to turn off the instrument.

Operation in Manual Mode

- Press and hold  for 3 seconds to turn on Manual Mode when the instrument is in Auto Mode or TILT Mode.
 -  Green LED is solid green, and  Red LED is solid red.
- The Auto-leveling function is off, the instrument can place at any less than 50° angle.
- Press and hold  for 3 seconds in Manual Mode to turn off Manual Mode, the instrument will back to Auto-leveling Mode.

Speed Switch/Spot Mode



- After Powered on and Auto-leveling or in Manual Mode (Not in SLOPE function), the default speed is 300rpm:
 - (1) Short press  to switch speed, followed by looping from 300rpm->600rpm->0rpm->300rpm;
 - (2) Short press  to switch speed, followed by looping from 300rpm->0rpm->600rpm->300rpm.
- At 0rpm or Scan Mode(Not in SLOPE function):
 - (1) Press  the laser dot will anticlockwise motion;
 - (2) Press  the laser dot will clockwise motion;
- At 0rpm:
 - (1) Short press  /  the rotation angle of laser dot is 10°.
 - (2) Long press  /  the laser dot will rotate at 0.5-1rpm.
 - (3) Press and hold  /  > 4 seconds, the laser will blinking 3 times to remind the laser start to speed up, after that the laser will rotate at 7.5-10rpm.
 - (4) Release  /  the laser dot will back to 0rpm.
- In Scan Mode:
 - (1) Short press  /  the scan angle will rotate 6°, the scan function is kept.
 - (2) Long press  /  the scan will be stopped, the laser dot will rotate at 0.5-1rpm.
 - (3) Press and hold  /  > 4 seconds, the laser will blinking 3 times to remind the laser start to speed up, after that the laser will rotate at 7.5-10rpm.
 - (4) Release  /  it will back to scan function.

Remark:



When the rotation speed is switched from 300rpm to 0rpm for 0.5 seconds, the output power of instrument will be low power, switched from 0rpm to scan function or rotation for 1 second, it will be high power.

Scan Mode

- Turn on the Scan Mode:





- (1) Short press  to turn on scan function, the default angle is 15°
- (2) Short press  again to turn off scan function.

- Scan angle switch:

- (1) Short press  to switch the scan angle, followed by loop from 15°->30°->60°->15°.
- (2) Short press  to switch the scan angle, followed by loop from 15°->60°->30°->15°.

TILT function

TILT Operation and Reset

- Press  to turn on the instrument;
 LED is blinking green when the instrument start to leveling.
Short press , the **TILT** LED will be solid green, the laser is glitter.
- After Auto-leveling, the laser starts to rotate.
- After Auto-leveling, if the instrument is tilted, it will be warning, the rotation will be stopped, and the laser is kept bright. **TILT** LED is solid red.
- Press  again, the instrument will reset and enter TILT function again, and re-leveling.

TILT Mode switch





- Press  to switch to Auto-leveling Mode in TILT Mode, TILT LED will be off.

Remark:

When the instrument is in Manual Mode, it can not switch to TILT function; If necessary, please resume to Auto Mode.

Operation in Slope function

Horizontal Slope function:

- First to turn on the Manual Mode after the instrument is powered on.
The  is solid green, and the  is solid red.
Short press  to enter the slope function, the  LED is solid green **• x**, it indicates the instrument is in X axis manual slope function.

Remark:

(In TILT Mode also need to enter the Manual Mode first, then press to enter the slope mode).

-  /  can control the laser tilt along the X axis.



Press  the laser will raise at +X direction of the instrument.

Press  the laser will lower at +X direct of the instrument.

*A single short press the laser will tile 20".

*Press and hold  /  > 1 second, the laser will tile 15"/second.

*Press and hold  /  > 4 seconds, the laser will tile 1°/second.

• The $\circ \cdot_{Y/Z}^x$ will blinking green when the tile is over run. Release  / , the $\circ \cdot_{Y/Z}^x$ will be solid green.

• Press  to switch to Y axis manual slope funtuon, the $\circ \cdot_{Y/Z}^x$ is solid red.

•  /  can control the laser tilt along the Y axis.

Press  the laser will raise at +Y direction of the instrument.

Press  the laser will lower at +Y direct of the instrument.

(The key-hold time and adjustment amount are same as X axis.)

• The $\circ \cdot_{Y/Z}^x$ will blinking green when the tile is overrun.



Release  / , the $\circ \cdot_{Y/Z}^x$ will be solid green.

• Short press  to quit slope function, and back to Manual Mode.

The $\circ \cdot_{Y/Z}^x$ is off,  is solid green and  is solid red;

The horizontal slope function can only be entered in Manual Mode, it will resume to Manual Mode when quit the slope function.

Vertical Slope function:

• When powered on in vertical state, enter the Auto-leveling Mode, the   is blinking green, and the instrument starts to leveling.

Short press  to enter the vertical slope function(Z axis is Autoleveling), the $\circ \cdot_{Y/Z}^x$ is solid red.

(In vertical TILT Mode also can enter Slope Mode, TILT and Slope function can exist concurrently)

• The operation of vertical slope function is the same as horizontal slope function.

• Short press  to quit slope function, and resume to Auto Mode.

Accuracy Check and Calibration

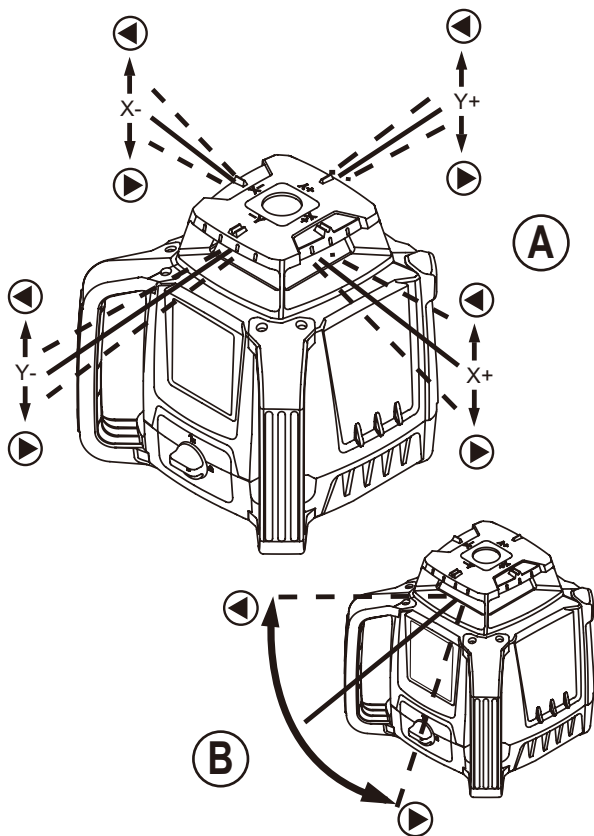

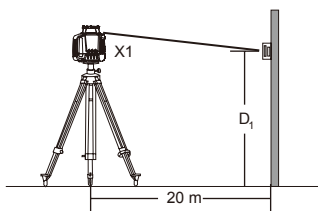

(C₁)

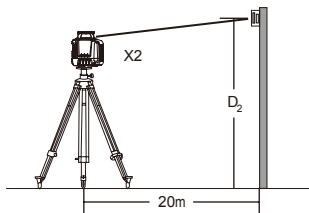

(C₂)

(C)

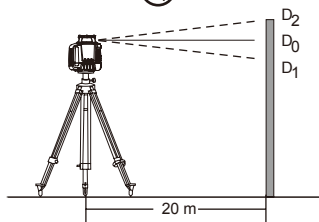

(C₃)

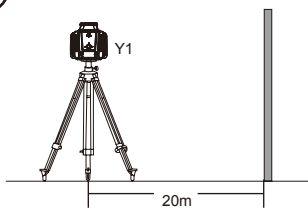

(C₄)

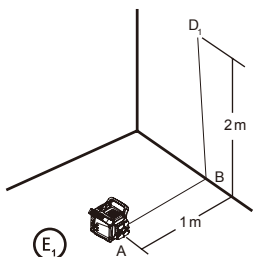

(E₁)

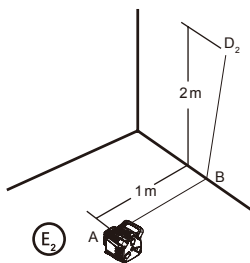

(E₂)

(E)

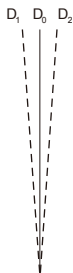

(E₃)

NOTE:

- See Feature Set to reference which models offer specific functions.
- The laser tools are sealed and calibrated at the factory to the accuracies specified.
- It is recommended to perform a calibration check prior to its first use and then periodically during future use.
- Be sure to allow the laser tool adequate time to Auto-Level (< 60 seconds) prior to a calibration check.
- The laser tool should be checked regularly to ensure its accuracies, especially for precise layouts.

Horizontal Check (See Figure C)

- Set the laser tool on a tripod 20 m away from a wall with the "X1" side facing the wall (C1).
- Power ON the laser tool and allow the laser tool to Auto-Level and be sure laser is rotating.
- Go to the wall and mark a reference point "D1" where the laser line is on the wall. If available, using a detector may help in locating the beam more easily.
- Loosen the laser tool from the tripod and rotate the laser tool 180° so that the "X2" side is now facing the wall (C2).
- Go back to the wall and measure the distance between the first reference point "D1" and the second reference point "D2" (C3).
- There is no need to adjust calibration if the distance between reference point "D1" and "D2" is < 2 mm.
- If the distance measured is ≥ 2 mm then a calibration adjustment is necessary.
- Perform the same steps for the "Y" axis as was done for the "X" axis. Replace "X1" and "X2" with Y1" and "Y2" (C4).

Vertical Check (See Figure E)

(Only necessary on models with Vertical Auto-Leveling)

- Set the laser tool on a stable surface in its vertical position 1 m away from a wall that extends ≥ 2 m high with the "Y1" side facing that wall. (E₁)
- Power ON the laser tool and allow the laser tool to Auto-Level and be sure laser is rotating.
- Mark reference points "A" (where laser line is on floor 1 m away from wall), "B" (where laser beam is at corner), and "D1" (where laser beam is 2 m up the wall). (E₂)
- Rotate the laser tool 180° so that the "Y2" side is now facing the wall.
- Align the laser beam with reference points "A" and "B" and then go back to the wall and measure the distance between the reference points "D1" and "D2". (E₃)
- There is no need to adjust calibration if the distance between reference point "D1" and "D2" is < 1 mm.
- If the distance measured is ≥ 1 mm then a calibration adjustment is necessary.

SPECIFICATIONS

Horizontal Rotary Accuracy:	$\pm 1.5 \text{ mm @ } 30 \text{ m}$
Vertical Rotary Accuracy:	$\pm 3 \text{ mm @ } 30 \text{ m}$
Vertical Up Beam Accuracy:	$\pm 3 \text{ mm @ } 30 \text{ m}$
Compensation Range:	$\pm 5^\circ$
Slope Range:	$\pm 10\%$
Minimum Increment:	0.01%
Scan Range:	$15^\circ, 30^\circ, 60^\circ$
Working range with Detector (φ)	0.5m ~ 500m
Leveling Time:	$\leq 20 \text{ seconds}$
Rotation Speed:	600/300/0 rpm $\pm 10\%$
Laser Class:	Class 2 (EN60825-1)
Laser Wavelength:	635 nm
Operating Time:	40 h(Li-Ion Battery Pack) / 30 h(4 * 2# Batteries)
Recharging Time:	$\leq 8 \text{ h}$
Power Supply:	Li-Ion Battery Pack / 4 * 2# Batteries
IP Rating:	IP66
Operating Temperature Range:	$-10^\circ \text{ C} \sim +40^\circ \text{ C}$
Storage Temperature Range:	$-20^\circ \text{ C} \sim +60^\circ \text{ C}$

MAINTENANCE AND CARE

- Handle measuring devices with care.
- Clean the device after every use with a soft cloth. If necessary, dampen the cloth with water.
- If the instrument gets wet, clean it and dry it carefully.
- Only put the laser away when it is completely dry.
- Remove the batteries or rechargeable batteries when switching off the laser for a long time.
- Do not use solvent to clean the laser.
- Only transport the laser in its original case.

! Do not leave the Prexiso laser in direct sunlight. Do not expose the laser to high temperatures.

The laser body and some internal parts are made of plastic and can warp at high temperatures. Do not store the laser in a very cold environment, as this can cause condensation to form on the internal parts when the laser is warmed up. This can mist up the beam windows and cause the internal circuit boards to rust.

POSSIBLE ERRORS

If the measurements calculated by the laser are incorrect, this could be caused by :

- use of the laser near plastic or glass windows.
- dirt or obstruction of the beam windows.
- the laser may have fallen over without your knowledge. This highlights the importance of regularly checking the laser's precision.
- extreme changes in temperature, e.g. using the laser in a cold environment after storing it in a warm environment. Wait a few minutes for the device to reach room temperature.

WARRANTY AND RESPONSIBILITY

The device has a 2-year basic warranty. This warranty does not cover breakdowns or faults which may have been caused by :

- incorrect use of the device.
- non-respect of the instructions described in the user manual.
- off cuts, poor handling, use of unsuitable batteries, poor electrical connections etc.

Repairs made other than by our factory, Prexiso service centre or authorized service station relieve Prexiso of further liability under this guarantee. This guarantee is made expressly in place of all other guarantees or warranties, expressed or implied, with respect to quality, merchantability, or fitness for a particular purpose.

LASERS ARE DESIGNED TO CARRY OUT ALL TYPES OF WORK REQUIRING HORIZONTAL OR VERTICAL ALIGNMENTS. ALL DEVICES ARE CHECKED AND THEN SHIPPED WITH PERFECT SETTINGS, BUT SHOULD ANY IMPACT OCCUR, A DEVICE MAY LOSE PRECISION OR EVEN COMPLETELY LOSE ITS SETTINGS.

THE USER MUST CHECK THE DEVICE REGULARLY AND BEFORE CARRYING OUT SUBSTANTIAL WORK.

We shall accept no responsibility for problems regarding the construction, installation, manufacture or assembly which may result from a device failure due to poor maintenance or hazardous connections to other devices.

RoHS-compliance

This product complies with the directive 2011/65/EU.

DISPOSAL

⚠ CAUTION

The battery must not be disposed with household waste. Care for the environment and take them to the collection points provided in accordance with national or local regulations. The product must not be disposed with household waste. Dispose of the product appropriately in accordance with the national regulations in force in your country. Adhere to the national and country specific regulations.

